

An-10®

Wireless lighting control technology

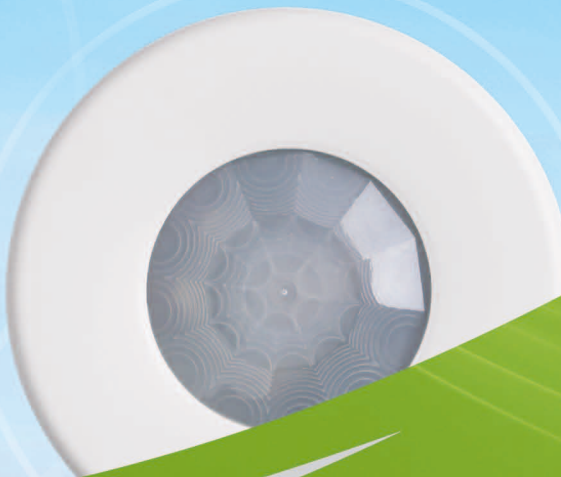

An-10®

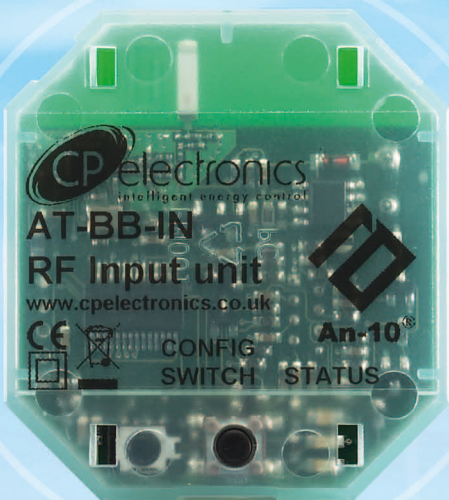

Welcome to CP Electronics

CP Electronics has been designing and developing lighting control solutions for the commercial, industrial and public sectors since 1970.



Innovative products, seamless support

In today's climate of growing environmental awareness and rising energy prices, saving energy is becoming more vital than ever.

At CP Electronics, we've been developing and manufacturing energy saving controls for lighting, heating and ventilation for almost 40 years.

Our experience and expertise can help you and your customers reduce your carbon footprint and save you money at the same time.

Our products can also help you comply with the latest issues of Government legislation and conformance with regard to environmental sustainability.

Accreditations

CP Electronics has achieved the following certified standards which reflect the highest levels of quality and performance:

BS EN ISO 14001:2004 – International recognition of the company's environmental management systems

ISO9001 Accreditation – International recognition of quality management systems

ESTA – Affiliated to the Energy Services and Technology Association

CE – All products where applicable carry the CE mark



An-10 wireless technology allows you to install a fully featured lighting control system easily and with minimal disruption

An-10 has been specifically created to allow you to embrace the advantages of wireless technology, while at the same time offering all of the features and functionality demanded by modern day lighting control systems.



Simple Installation

- Wireless signals can pass through walls, floors and ceilings, so you can position switches and detectors exactly where you need them.
- No need to run costly control wires between devices or back to a central controller.
- Reduces installation times and minimises disruption, making it an ideal solution for retrofit and new builds alike.
- Easier to meet building regulations and today's demands for greater energy efficiency.
- Ideal for historic and listed buildings where disturbing the building fabric is difficult or impossible.



Flexible Functionality

- System functionality is achieved by programming, not hard wiring, making it incredibly easy to design the operation of your lighting control system.
- If you need to reorganise your living or working space, simply move and/or reprogram devices for the new layout. This is particularly useful for open-plan environments.



Easy Expansion

- Adding extra devices is simple. No additional control wiring is required; simply install the extra device, program it into the system and you are ready to go!

Cost effective, safe and dependable

Cost Effective

As well as being competitively priced, the An-10 system offers considerable savings over conventional wireless lighting control systems, whilst providing a very cost effective alternative to conventional wired systems.

The An-10 wireless range achieves significant reductions in total system cost through cheaper installation.

An-10 allows for a system to be expanded simply and cost effectively.

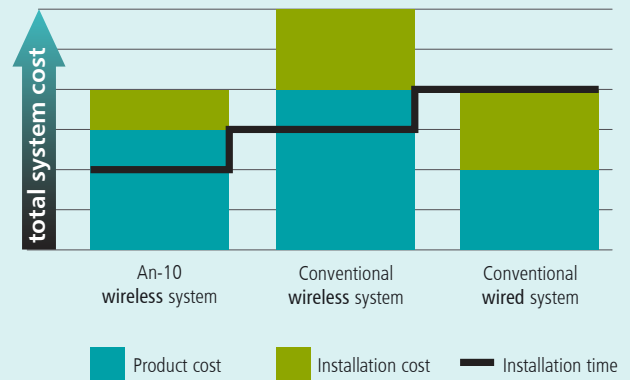

Completely Safe

Concern about being exposed to radio waves is something we take very seriously. Wireless technology is already in common usage around the home and in the workplace, such as in alarm systems and computer networks.

The An-10 product range is fully compliant with European Regulations [ETSI EN 300 220-1 V2.1.1 (2006-04)] making it completely safe to use in sensitive environments like schools.



Dependable

Wireless radio frequency (RF) devices are often perceived to be less reliable than their wired counterparts. Not so with An-10.

An-10 uses a unique 'hybrid mesh' network topology, together with a communication protocol, that has been specifically designed to meet the needs of lighting control.

Control messages are routed only to specific devices according to the needs of the system. Compared to other wireless lighting systems, An-10 significantly reduces the amount of data traffic generated, resulting in faster and more efficient operation.

Furthermore, unlike other systems, An-10 makes multiple attempts to deliver a control message. The ability to redirect control messages in different ways around the network gives An-10 exceptional immunity to transient conditions such as interference from other RF systems.

The An-10 hybrid mesh network in action

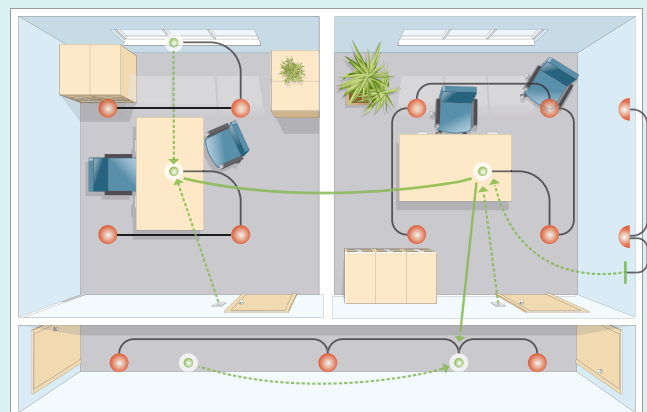

- Switching and/or dimming of lighting load
- - - Wireless communication between units within room
- Wireless communication between rooms
- Luminaires
- Detectors

Flexible, independent device addressing

An-10 Device Addressing

Every An-10 device within a system uses a number of different address codes that identify its place within that system and how it interacts with other devices.

A **Building Code** is used to identify devices that form part of the same overall system. This allows An-10 systems in adjacent buildings to be completely independent and prevents cross-system interference.

A **Local Code** typically defines all devices in a specific location. For example, the switch plates, sensors and dimmers in one room may all share the same Local Code so that only the devices in that room are controlled and do not affect, or are affected by, devices in other rooms. An optional **Sub Local Code** can also be used to further subdivide devices within a room if required.

One or more **Area Codes** will allow common control across multiple locations. Typical applications of Area Codes include 'corridor hold' schemes (see page 17).

Building Code

Defines all devices in one building or location.

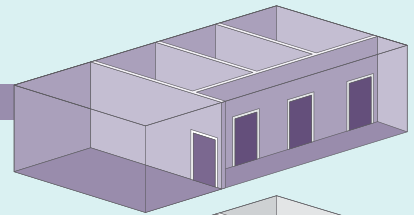

Local Code

Defines all devices in one room.

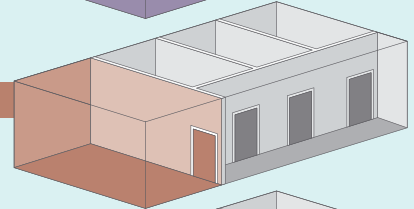

Sub Local Code

Defines all devices within a region of one room.

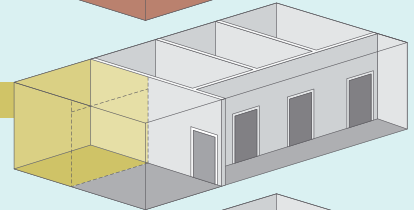

Area Code

Defines all devices within two or more rooms where common control is required.

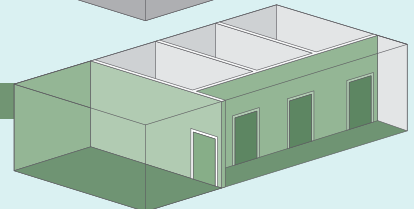

Scene selection functionality

The Perfect Lighting Level at the Flick of a Switch

Scene selection allows the recall of pre-programmed lighting levels to create different moods or to suit different uses within an environment.

A scene is a selection of circuits that are set to individual lighting levels and stored. They can then be invoked by a switch connected to the An-10 input unit or the presence detector detecting a person.

For example, in a meeting room you may want one scene that sets all lights at maximum level for meetings, but another scene that sets the individual circuits to different levels for presentations.

An-10 allows up to 20 local scenes and up to 120 area scenes that can be easily programmed via infrared handsets.

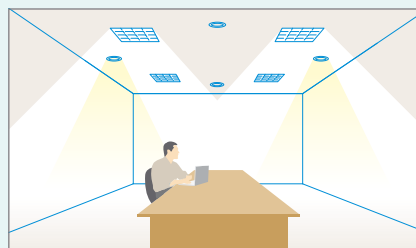

Scene 1.
All modular luminaires on and left and right downlights dimmed for hot desk working.

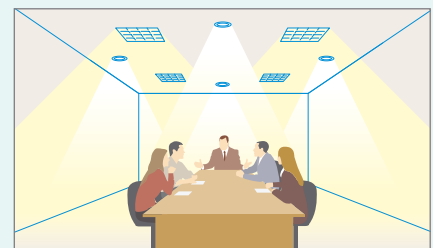

Scene 2.
Modular luminaires dimmed and downlights on for meeting.



Scene 3.
Modular luminaires off and downlights dimmed for presentation. One by screen is off.

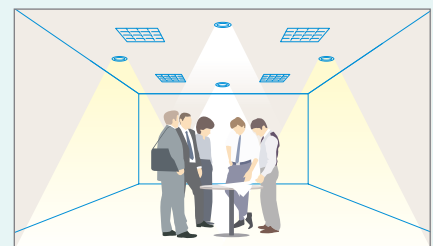

Scene 4.
Downlights on for informal gathering.

Presence and absence detection explained

Presence Detection

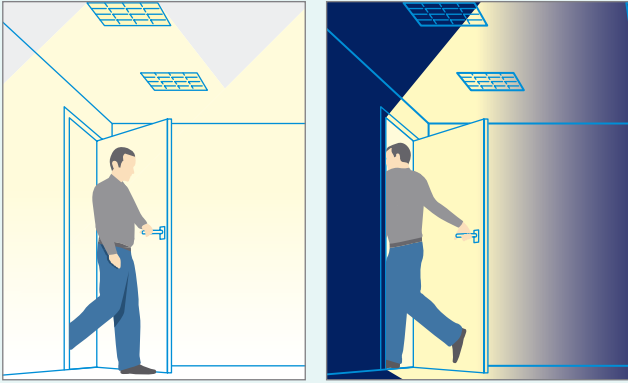

Presence detection uses a detector to automatically turn lights on when a room is occupied and off when the room is empty.

Absence Detection

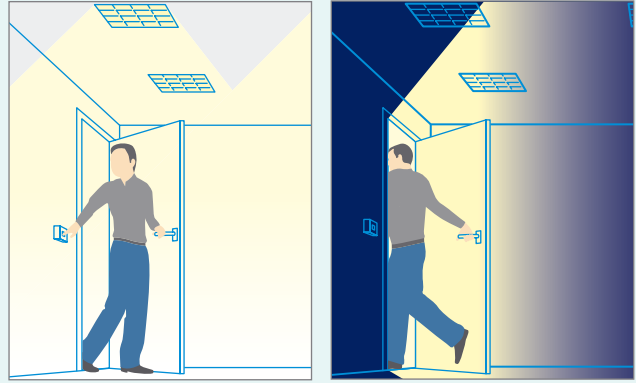

Absence detection requires a user to manually turn lights on using a wireless switch input unit, and a detector turns the lights off when the room is empty.

An-10 detectors provide absence or presence detection.

An introduction to detector types:

Switching detectors with lux level sensing

Introducing Daylight Linked Switching

The PRM detectors provide on/off load control. They can be easily programmed via the infrared (IR) handset for either presence or absence detection.

In absence mode the An-10 input unit can be wirelessly connected to one or more switch input devices to provide the manual switching signal. These presence detectors have a built-in adjustable lux level sensor that keeps the lighting switched off if there is sufficient natural light.

The occupancy detector in the An-10 detector can also be used to control the outputs in other detectors, An-10 slim-line ballast controllers and Vitesse Modular adaptors via the wireless system.

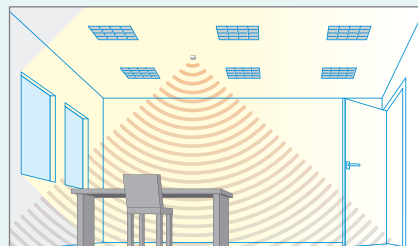

No presence detected, daylight, lights off.

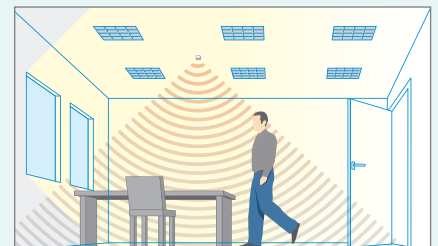

Presence detected, sufficient daylight, lights off.

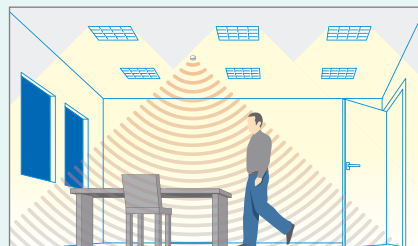

Presence detected, insufficient daylight, all lights on.

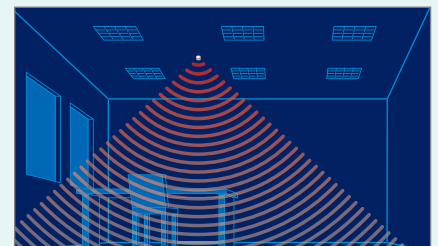

No presence detected, lights off.

Dimming detectors with lux level sensing

The Highest Level of Technology

The dimming detectors provide both on/off load control and dimmable control of either DSI/DALI digital ballasts or 1-10V analogue ballasts.

They can be easily programmed via the IR handset for either presence or absence detection. In absence mode the An-10 input unit can be wirelessly connected to one or more switch input devices to provide the manual switching signal and scene selection.

The occupancy sensor and the lux level sensor in the An-10 detector can also be used to control multiple outputs in other detectors, An-10 slim-line ballast controllers and Vitesse Modular adaptors via the wireless system. These detectors have the following functions in addition to those found in the PRM detectors.

Maintained Illuminance (illustrated below)

Where natural light is available, dimming the luminaire allows the level of artificial lighting to be balanced with daylight, maintaining a near constant light level (maintained illuminance). This is also known as 'daylight harvesting' or 'daylight linking'.

Maintained illuminance can be combined with either presence or absence detection to ensure that lights are only turned on when absolutely necessary. The photocell in a detector measures the surrounding light level and adjusts the An-10 outputs to a preset lux level. The same light level information can be shared with other devices to ensure uniform output levels across an area.

Step Down Illuminance

In certain instances it may be undesirable to simply switch off light should no movement or presence be detected. An-10 outputs can be programmed to switch off light completely, or lower its level to a predefined value or scene, upon sensing no movement.

Lamp Burn-in

Dimming new lamps within the first hours of use can shorten their life and invalidate some manufacturers' warranties. An-10's 'Burn-in' feature prevents new lamps from being dimmed for this initial period.

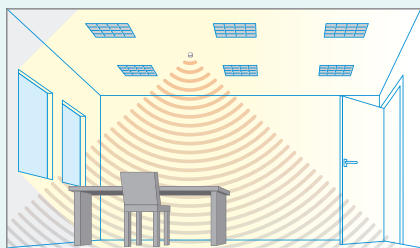

No presence detected, daylight, lights off.

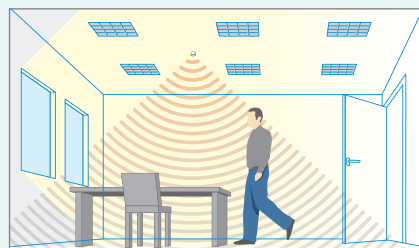

Presence detected, sufficient daylight, lights off.

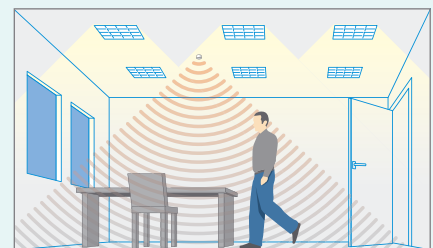

Presence detected, some daylight. Lights on and dimmed to maintain lux level.

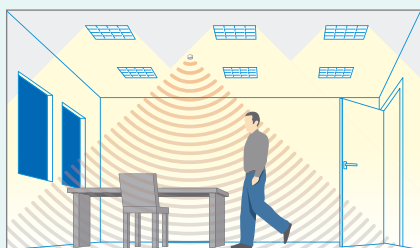

Presence detected, insufficient daylight. Output device measures and implements maintained illuminance.

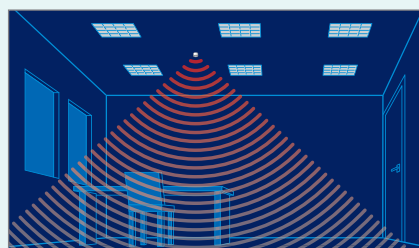

No presence detected, lights off.

Slim-line Ballast Controllers

- Switched or dimmable control of DSI/ DALI or 1–10V ballasts.
- Available as a standalone unit or built-in unit for integration into 3rd party luminaires.

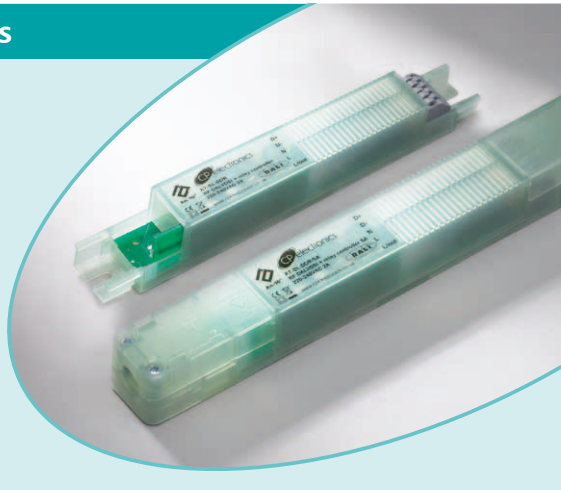

Adjustable Ceiling Mounted Microwave

- Microwave presence detectors are sensitive to movement and are ideal for large or awkwardly shaped spaces.
- This presence detector is available in switching or dimming. Please see pages 6-7 for more information.



Switch Input Unit

- Up to 7 volt-free inputs for use with standard or custom-made switch/button plates.
- Simple configuration presets for typical scene selection and raise/lower operation. Advanced set up features for master override selection, etc.
- Powered by internal long life battery or optional external 12V supply.

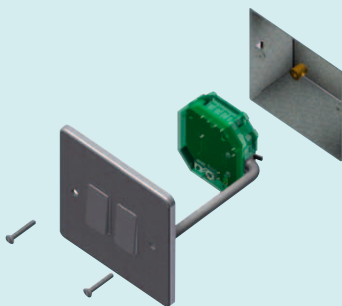

Compact design allows installation into standard UK and European backboxes

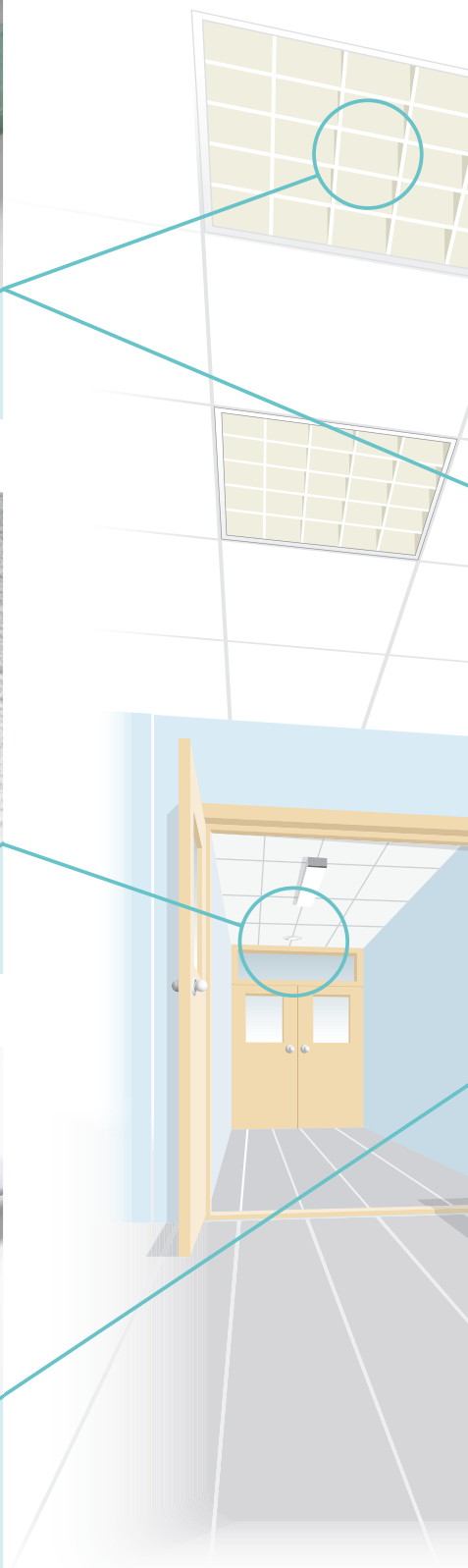

An-10 wireless technology allows you to install a fully featured lighting control system

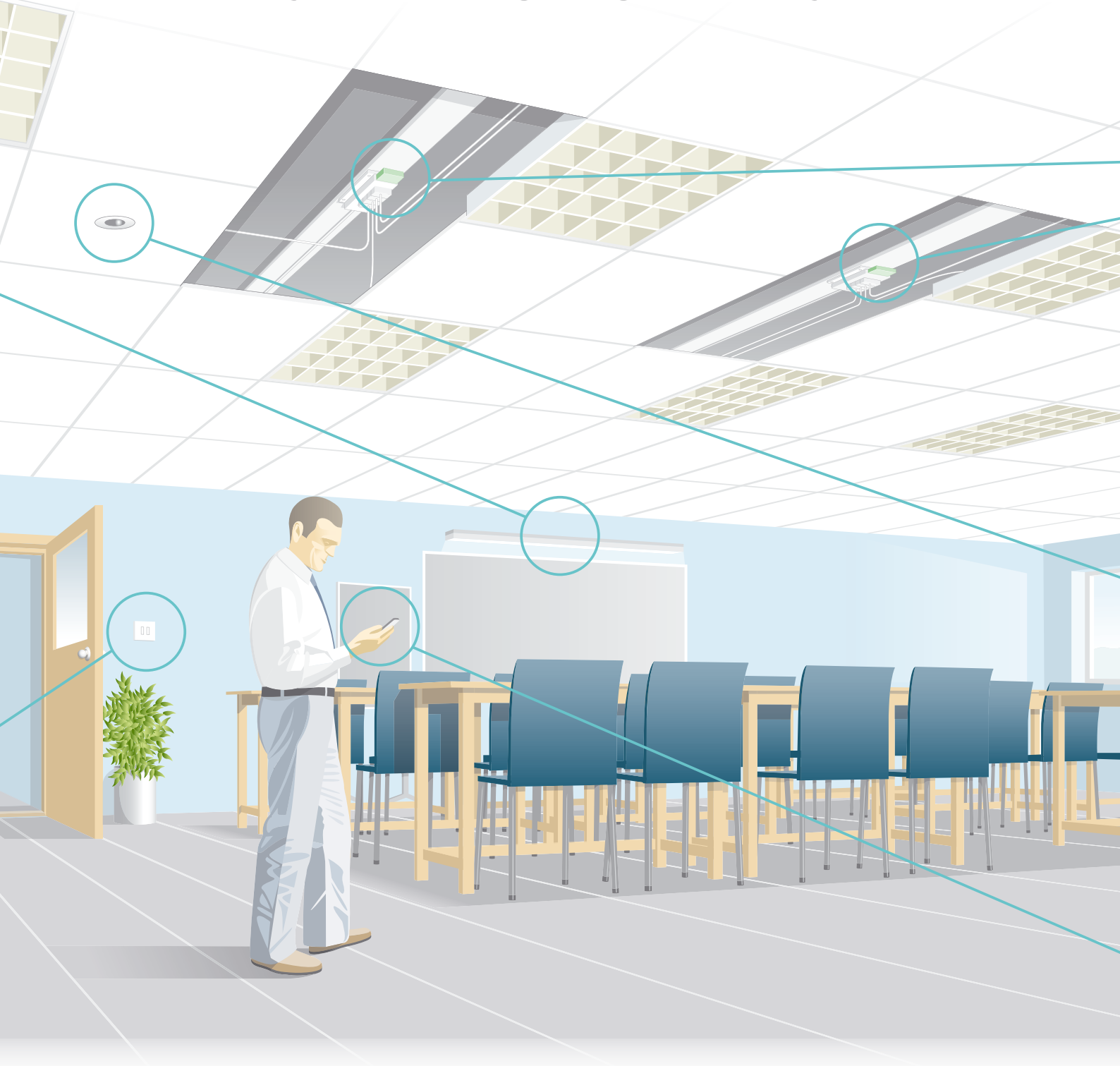

Please see pages 14–17 for sample configurations



Vitesse Modular™ Adaptors

- Allows the An-10 system to work with the Vitesse Modular lighting distribution range.
- Simple plug-in design, available in both switched and dimming versions.

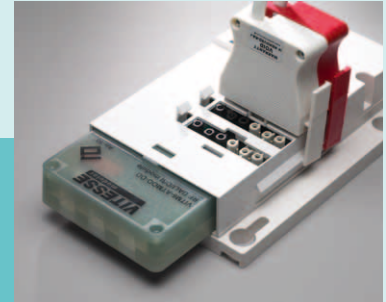

Vitesse Modular is our state of the art lighting distribution system that can be easily adapted for layout changes and expansion. For more information please see the Vitesse Modular range in our main catalogue.



Ceiling PIR Presence Detectors

- PIR presence detectors detect body heat and movement making them ideal for smaller spaces or where a defined detection pattern is required.
- The EBDSPiR is available as a switching or dimming detector. Please see pages 6–7 for more information.



Infrared Handset

- Compact and lightweight design.
- Multi-functional operation for configuration of detectors, ballast controllers and input units.
- User control of scene selection and raise/lower functions.

Slim-line Ballast Controllers



Available as standalone (SA) units for general use or built-in units for integration into 3rd party luminaires.

Order Code	Description
AT-SL-R	Wireless (RF) slim-line relay controller (luminaire mounted)
AT-SL-R/SA	Wireless (RF) slim-line relay controller (standalone)
AT-SL-DDR	Wireless (RF) slim-line relay controller with DSI/DALI dimming (luminaire mounted)
AT-SL-DDR/SA	Wireless (RF) slim-line relay controller with DSI/DALI dimming (standalone)
AT-SL-ADR	Wireless (RF) slim-line relay controller with 1–10V analogue dimming (luminaire mounted)
AT-SL-ADR/SA	Wireless (RF) slim-line relay controller with 1–10V analogue dimming (standalone)

Supply Voltage	230VAC +/- 10%
Frequency	50Hz
Relay Rating	2A
Terminal Capacity	1.5mm ² (luminaire mounted)
	2.5mm ² (standalone)

Dimensions

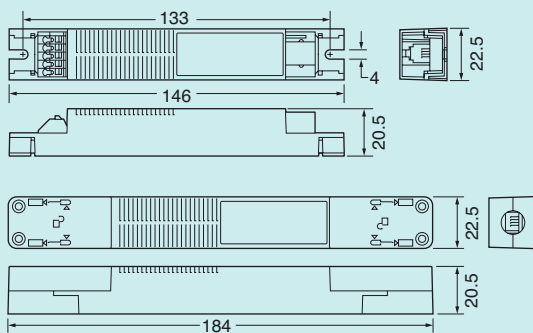

All dimensions in mm

PIR Presence Detectors



Order Code	Description
EBDSPIR-AT-PRM	Wireless (RF) ceiling PIR presence/absence detector with lux level sensing
EBDSPIR-AT-DD	Wireless (RF) ceiling PIR presence/absence detector with DSI/DALI dimming
EBDSPIR-AT-AD	Wireless (RF) ceiling PIR presence/absence detector with 1–10V analogue dimming
DBB	Surface mount backbox

Supply Voltage	230VAC +/- 10%
Frequency	50Hz
Relay Rating	10A
Terminal Capacity	2.5mm ²

Dimensions

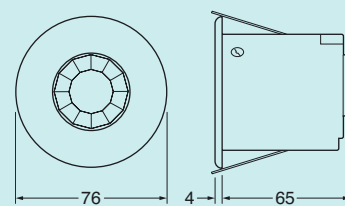

All dimensions in mm

Detection Pattern

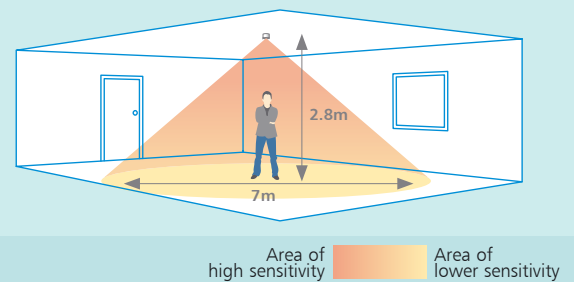

Microwave Presence Detectors



Head can be angled to suit the detection pattern required



Order Code	Description
MWS3A-AT-PRM	Wireless (RF) ceiling microwave presence/absence detector with lux level sensing
MWS3A-AT-DD	Wireless (RF) ceiling microwave presence/absence detector with DSI/DALI dimming
MWS3A-AT-AD	Wireless (RF) ceiling microwave presence/absence detector with 1–10V analogue dimming
MWS3A-DBB	Surface mount backbox
MWS3A-DBB-WBRKT	Wall mounting bracket for MWS3A series

Supply Voltage	230VAC +/- 10%
Frequency	50Hz
Relay Rating	10A
Terminal Capacity	2.5mm ²

Dimensions

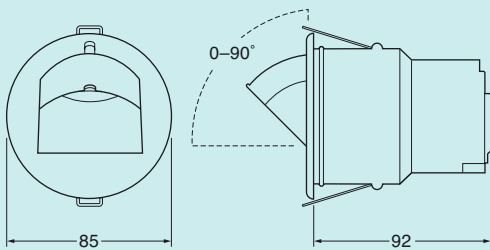

All dimensions in mm

Detection Pattern Examples

Corridors

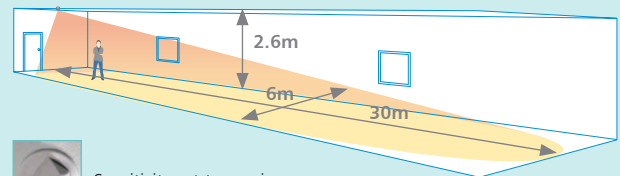

Sensitivity set to maximum
Detector head position set to 80°

Large office or classroom

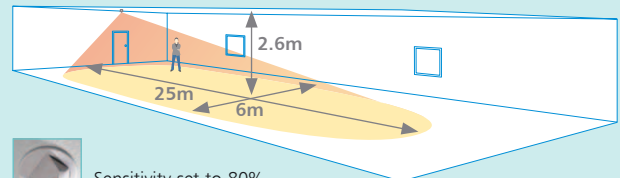

Sensitivity set to 80%
Detector head position set to 80°

Mid-sized office

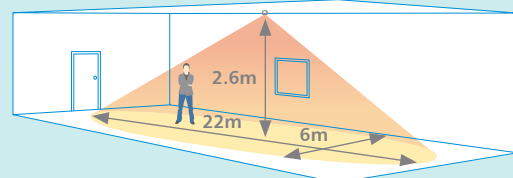

Sensitivity set to maximum
Detector head position set to 0°

Area of high sensitivity  Area of lower sensitivity

Vitesse Modular™ Adaptors

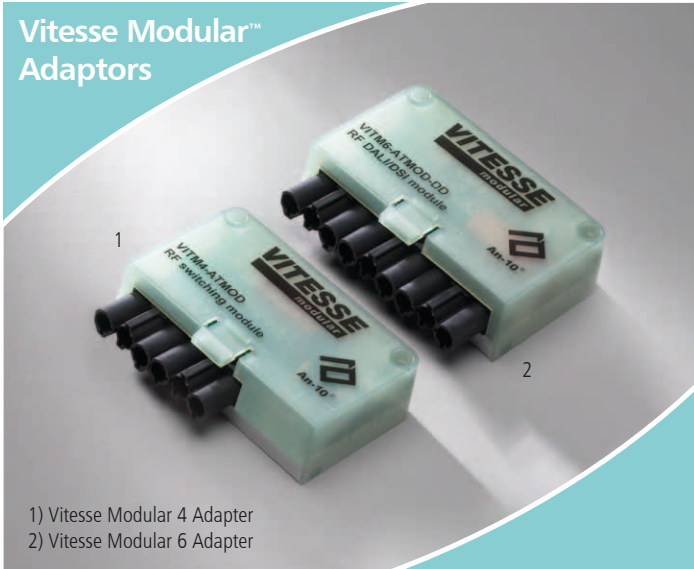

1) Vitesse Modular 4 Adapter
2) Vitesse Modular 6 Adapter

Switch Input Unit

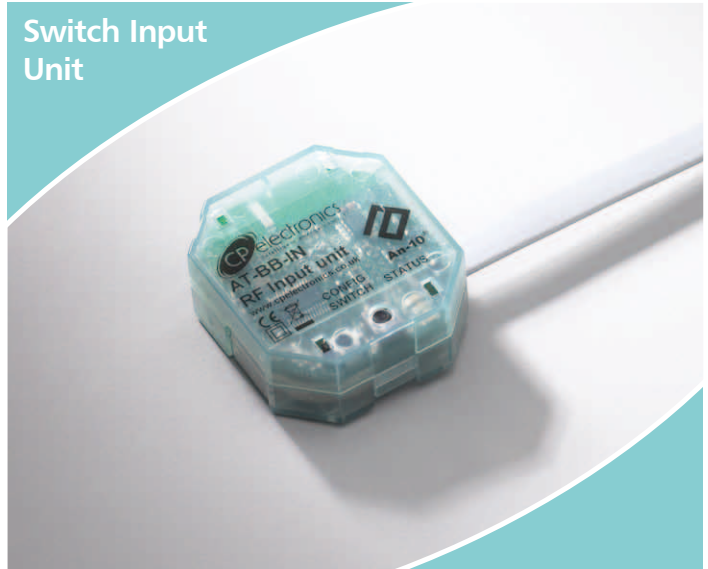

Order Code	Description
VITM4-ATMOD	Wireless (RF) interface module for Vitesse Modular switching
VITM6-ATMOD-DD	Wireless (RF) interface module for Vitesse Modular DSI/DALI dimming
VITM6-ATMOD-AD	Wireless (RF) interface module for Vitesse Modular 1–10V analogue dimming
VITM4-L3-AT-PRM	Vitesse Modular 4 pole 3m detector lead for PRM An-10 detector
VITM6-L3-AT-DD	Vitesse Modular 6 pole 3m detector lead for DD/AD An-10 detector
VITM4-LD3-AT-PRM	Vitesse Modular 4 pole 3m dual detector lead for PRM An-10 detectors
VITM6-LD3-AT-DD	Vitesse Modular 6 pole 3m dual detector lead for DD/AD An-10 detectors
Supply Voltage	230VAC +/- 10%
Relay Rating	10A
Frequency	50Hz

Order Code	Description
AT-BB-IN	Wireless (RF) switch input unit
Battery	3V, type CR2477
Battery Life	> 7 years (typical)
Optional Supply	12Vdc regulated, 50mA

Dimensions

All dimensions in mm

Infrared Handset



Order Code	Description
UHS4	An-10 infrared programming handset
Dimensions	86 x 4 x 67mm

Common Specifications

Range	The maximum RF range between An-10 devices is 100m in free air and up to 30m indoors. However the materials used within a building will vary and this will impact upon the RF range. In reality the nature of how the An-10's hybrid-mesh works means that in most scenarios the individual range of an An-10 product will not be important.
Radio Frequency	868MHz
Receiver Class	2
Transmitter Duty	<10% on g3 band (default band) <0.1% on g2 band <1% on g1 band
Temperature	0°C to 35°C
Humidity	5 to 95% non-condensing
Compliance	EN 300 220-2 V2.1.2 EN 301 489-1 V1.8.1 EN 301 489-3 V1.2.1 LVD-2006/95/EC

Small office

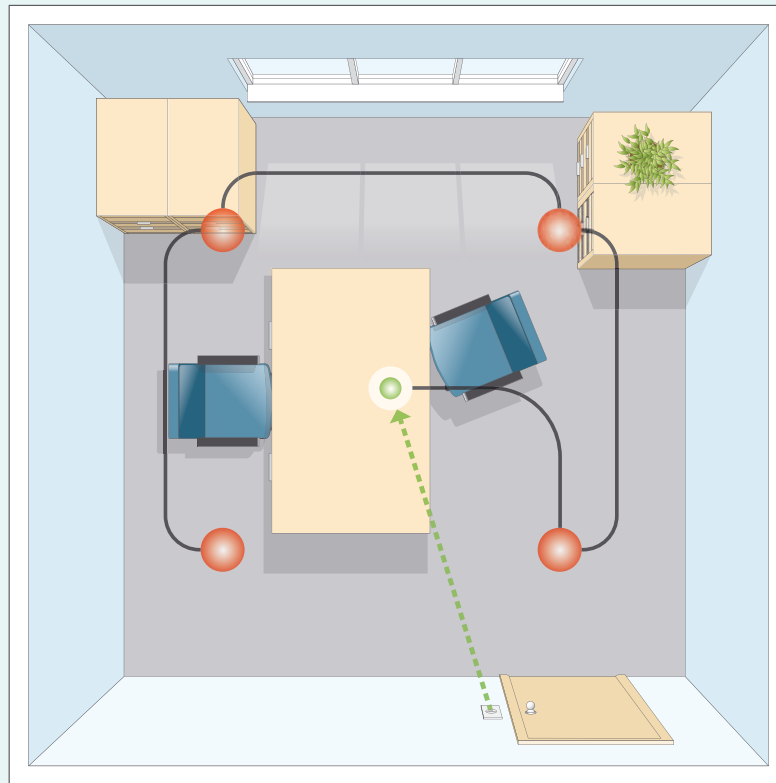





Set-up

- Four ceiling lights are controlled by the dimmable output of a PIR detector.
- The PIR detector is configured for absence detection.
- A push-button wall plate is connected to a concealed switch module.
- All An-10 devices are set to the same Local Code.

Operation

- Pressing a button on the wall plate sends a wireless message to the PIR detector which either turns the lights on, sets them to a preset level, or turns them off.
- The lights are automatically turned off when the room is unoccupied.

-  Luminaires
-  Detectors
-  Switching and/or dimming of lighting load
-  Wireless communication between devices

Meeting room

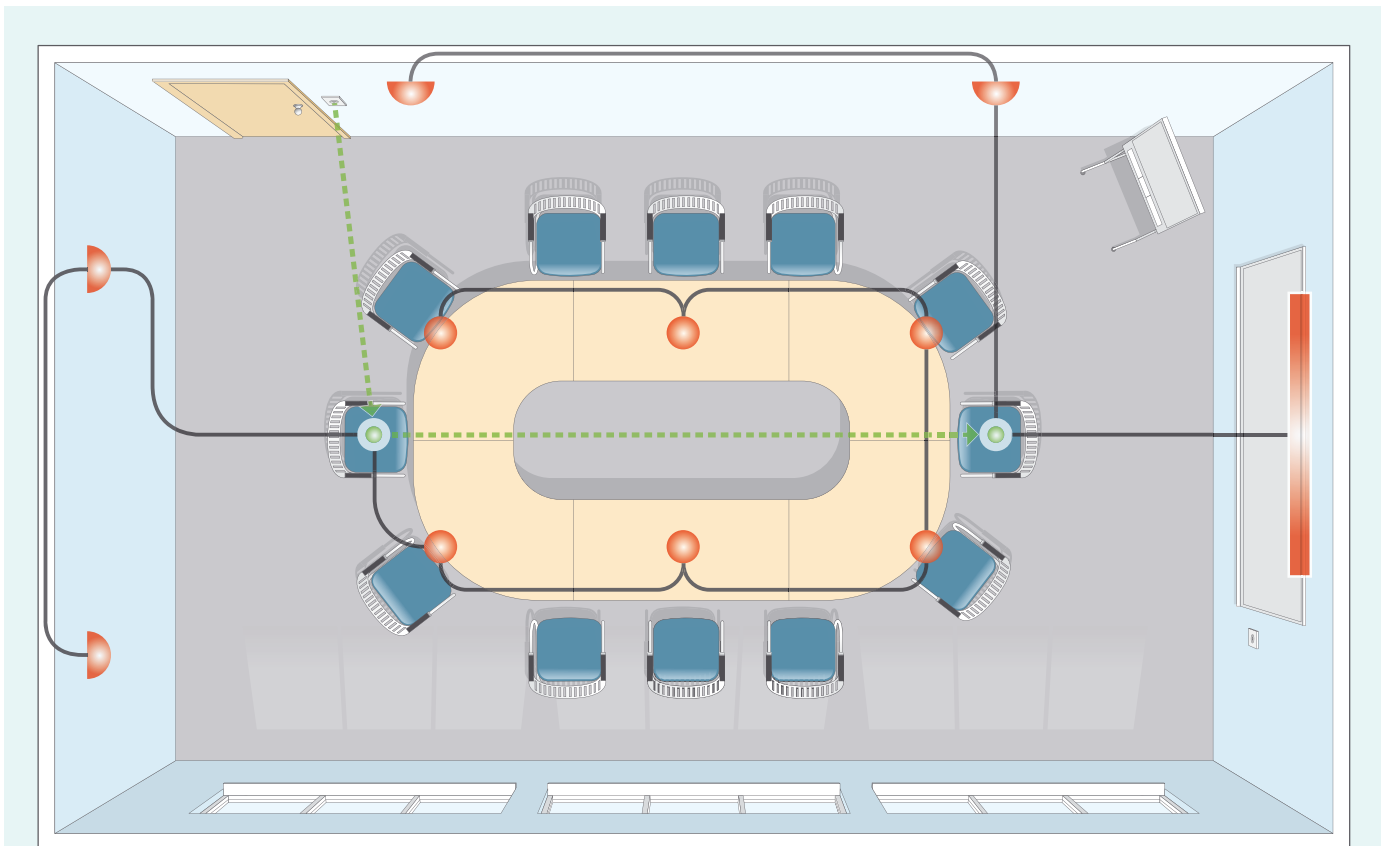

Set-up

- Two PIR detectors are used, with their switched and dimmed outputs controlling separate lighting circuits. This provides independent dimmable control of the wall lights, and switched control of the ceiling lights and wipe board strip light.
- Both PIR detectors are configured for presence detection.
- Two push-button wall plates are connected to concealed switch modules, providing convenient lighting control from either the entry door or projection screen positions.
- All An-10 devices are set to the same Local Code.

Operation

- The lights turn on automatically when someone first enters the room.
- Pressing a button on either wall plate sends a wireless message to the PIR detector, changing the lighting mood (scene) to suit a meeting or presentation.
- All lights are automatically turned off when the room is unoccupied.

- Luminaires
- Detectors
- Switching and/or dimming of lighting load
- - - Wireless communication between devices

Classroom

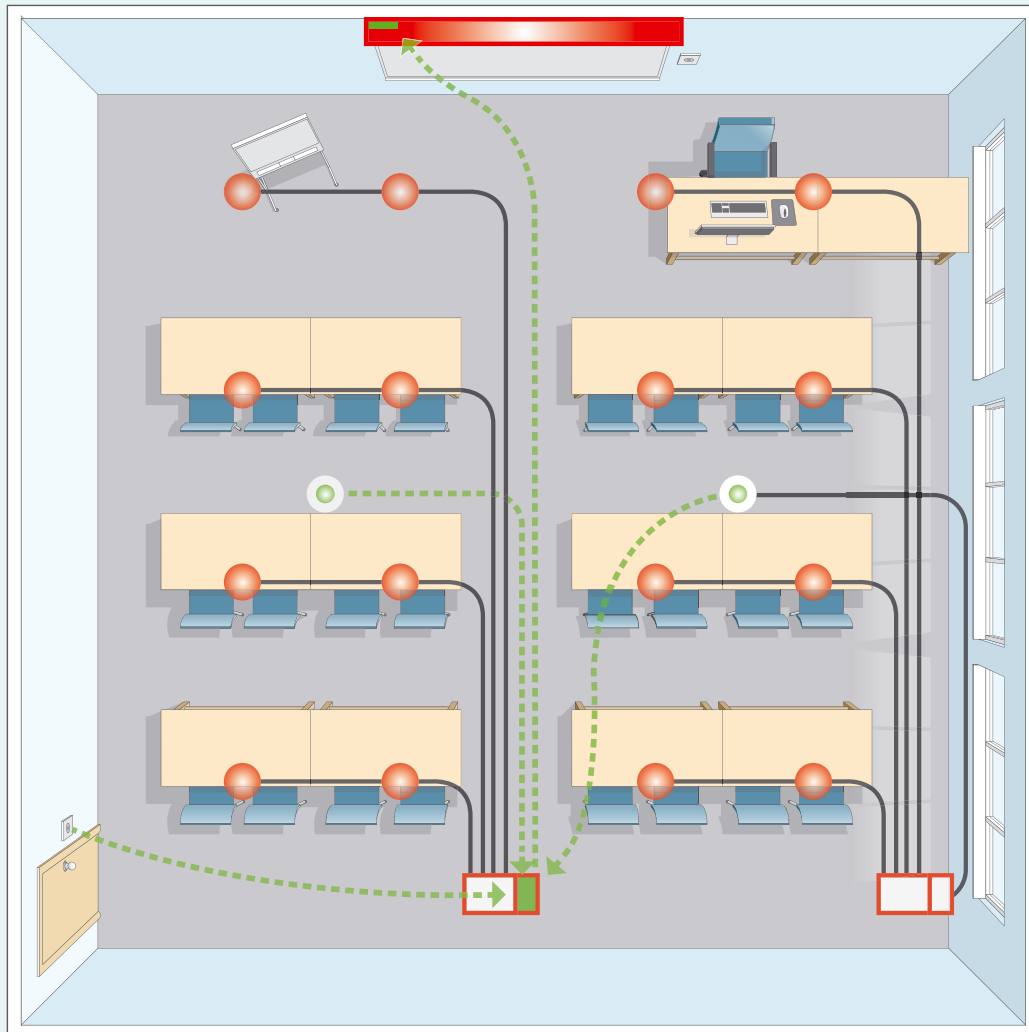

Set-up

- In this example the ceiling lights were previously wired using the Vitesse Modular lighting distribution system. The addition of an An-10 modular adaptor adds wireless control capability.
- The wipe board strip light is controlled by a slim-line ballast controller.
- Two PIR detectors are configured for absence detection and maintained illuminance operation.
- Two push-button wall plates are connected to concealed switch modules, providing convenient lighting control from either the entry door or projection screen positions.
- All An-10 devices are set to the same Local Code.

Operation

- Pressing a button on either wall plate sends a wireless message to the modular adaptors and slim-line ballast controller, which either turns the lights on, sets them to a preset level, or turns them off.
- The PIR detectors provide feedback of the overall light level and enable the system to dim the ceiling lights according to the amount of natural daylight.
- All lights are automatically turned off when the room is unoccupied.

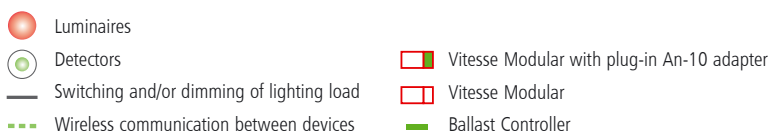

Offices and corridor

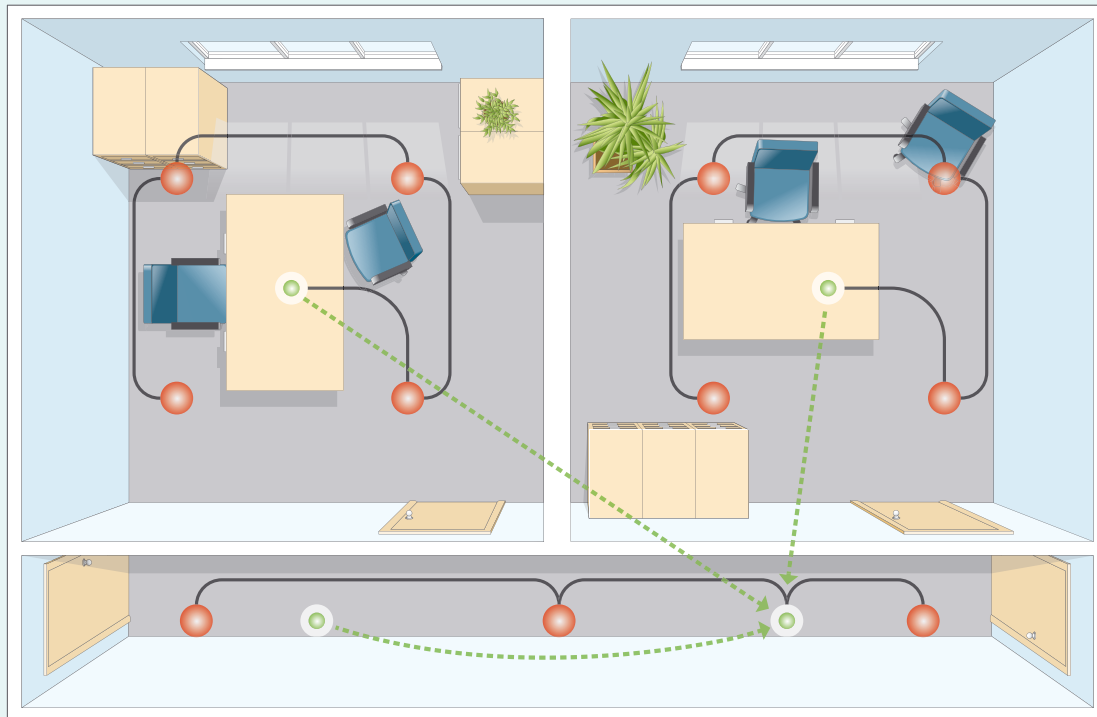

Set-up

- In each office the ceiling lights are controlled by a PIR detector.
- Two PIR detectors are used in the corridor, but note that only one detector is physically connected to the lights. The other detector communicates wirelessly with the first. Corridor lights are turned on as soon as one of the detectors picks up movement.
- All PIR detectors are configured for presence detection.
- An-10 devices are set to different Local Codes in each office and in the corridor, allowing each to function independently.
- Area Codes are set to allow common control between each office and the corridor.

Operation

- On entering the corridor, its lights are turned on automatically. Similarly, entering either of the offices will turn their lights on.
- All office lights are automatically turned off when the corresponding office or corridor is unoccupied.
- However, while either office is occupied, the An-10 system uses the Area Code to hold the corridor lights on for safety and convenience.

- Luminaires
- Detectors
- Switching and/or dimming of lighting load
- - - Wireless communication between devices

A wide range of products and integration expertise



Presence detectors

A wide range of passive infrared (PIR) and microwave presence detectors for the automatic control of lighting, heating and ventilation.



Light level controls

Intelligent photocells provide switching and maintained illuminance. They are suitable for use in internal and external applications.



Lighting control systems

Vitesse Modular™ is a state of the art lighting distribution system that can be used in a wide range of applications.



OEM and integrated products

CP Electronics offer a wide range of products and integration expertise.

Sales support

Our UK-based team are knowledgeable and experienced, and we take pride in providing a personal, non-automated service.

Technical support

From initial briefing and advice to commissioning, we assess your needs to apply the right solution.

Stock

Our stock control and scheduling processes ensure a high level of stock availability.



Tried and tested

"As a planning and environmental consultancy that operates an ISO 14001 Environmental Management System, the RPS London Office takes sustainability very seriously.

"We have implemented an energy efficiency scheme which focuses in particular on the office lighting.

"The An-10 lighting scheme will save an estimated 42,500 kWh of electricity per year, equivalent to 15 tonnes of CO₂. This is broadly equivalent to taking 10 family cars off the road. The installation of An-10 was quick and un-intrusive due to its wireless technology, and we are very happy with this feature-packed product."

Janet Kelly, Facilities Manager



RPS



CP Electronics
Brent Crescent
London
NW10 7XR
United Kingdom

t. +44 (0)333 900 0671

f. +44 (0)333 900 0674

info@cpelectronics.co.uk

www.cpelectronics.co.uk